

Chengdu Jiexun Electronics Com.,Ltd



User Manual v1.8

JXDH-6502 QPSK Modulator

(Sending Signal To Satellite)

Chapter 1 Product Outline

1.1 Outline

QPSK digital TV modulator adopts advanced digital signal processing technology, of which receiving port can directly use digital satellite receiver for receiving, thus fully complying DVB-S standard. Not only can it gain relatively high frequency spectrum usage ratio, having very strong anti-interference and relatively high price performance ratio, but also it can well comply analogue FM microwave equipment.

QPSK digital TV modulator adopts various processing method, such as random energy spread processing, RS coding, convolution interweave, contracting convolution coding, and pre-modulating baseband shaping processing, etc. all these contribute a high guarantee to the data transmitting performance.

1.2 Features

- Comply with DVB-SETS300-421 QPSK modulating standard;
- Frequency output range 1238-1278MHz
- Adopt DDS, high stabilization of output frequency, narrow frequency step, low phase noise
- Out Interface to connect 10M oscillator
- Big input stream
- Support input system efficient rate real time detect display and alarm display;
- Output level is adjustable from 0-20dB,0.5db/step through adjust the panel.
- Interface meet AS standard;
- Capacity stable and reliable, strong anti-jamming.
- RF level output delay

Apply

- MMDS digital TV head end;
- Satellite digital TV broadcasting;
- Terrestrial digital TV;
- Image Supervise;
- Video-On-Demand (VOD) ;
- Long-distance teaching;
- Video Conference.

1.3 Performance indicators

Modulate mode		QPSK
Input port		ASI standard port
Output port		50Ω N head
Input TS level		(800±10) mV
Frequency output range		(1238~1278) MHz
Output frequency adjustable step		Wide:125KHz, narrow:5Hz
10M oscillator input level		≥10dBm
Max Output level		≥0dBm
Output level adjustable range		0~20dB (0.5 dB step)
Symbol rate		3~10MBauds
FEC		1/2、2/3、3/4、5/6、7/8 for random option
Miscellaneous	Dimension	44mm×482mm×430mm
	Temperature	0~45℃ (work); -20~80℃ (storage)
	Power	220VAC±10%, 50Hz, 25W
	Installation hole distance	460mm

1.4 System composing and principle

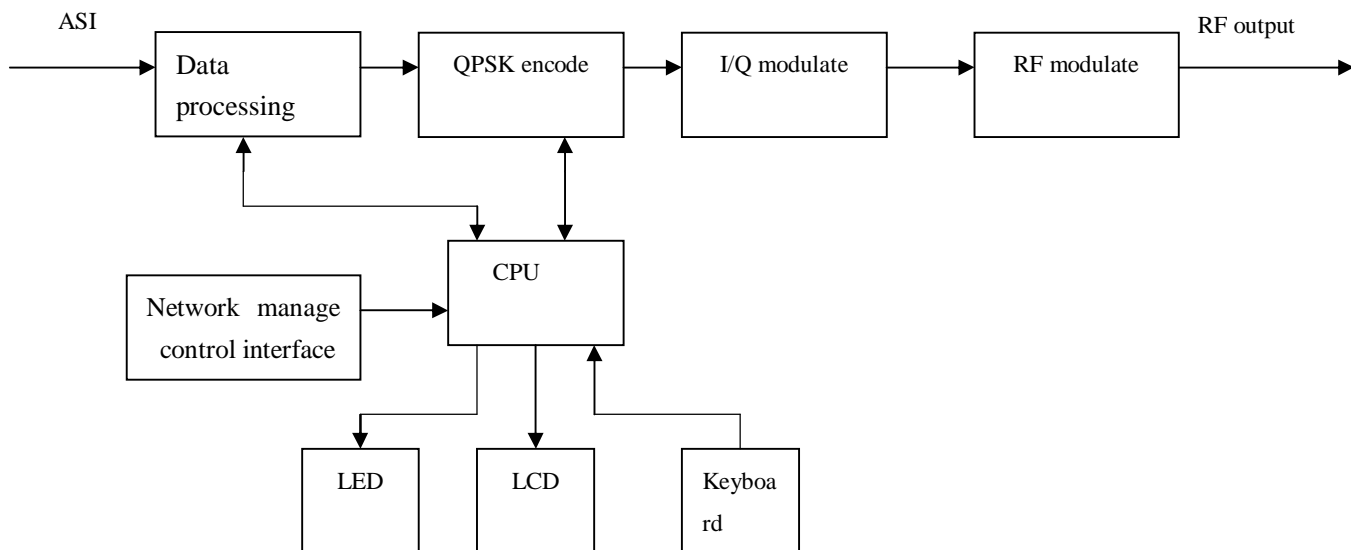

QPSK Modulator composed as below main module :

Digital disposal cell transform the input signals to standard signals and make essential data processing, to achieve QPSK modulate pretreatment.

QPSK modulate cell transform data stream to Frequency Spectrum signal. Modulator output RF signal from 250-750MHz、450-1000MHz or 950-2150MHz.

CPU/LCD/LED/keyboard cell finish keyboard input, LED display and intelligent control etc.

Principle: JXDH-6502QPSK modulator comply with DVB-S standard, television signal duplicate process via MPEG-2 compress encode and other date stream, then deliver to QPSK modulator, QPSK encode is according to DVB technical criterion, such as FEC encode, RS correct encode etc.. after disposal by uplink frequency conversion and then output to TV channel and microwave channel, in order to broadcast in HFC, microwave MMDS internet, available for digital TV, digital broadcasting, video order, internet, video conference etc. such digital broad band apply system.

1.5 Appearance and description

Front panel illustration:

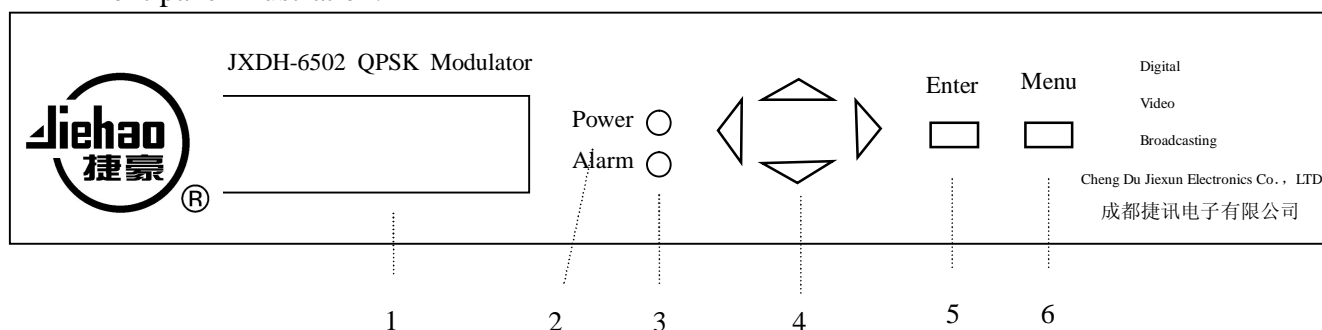

- 1: LCD screen display
- 2: Power indicator
- 3: TS signal detect alarm indicator
- 4: UP/DOWN/LEFT/RIGHT button
- 5: Confirm button
- 6: Menu button

Back panel illustration:

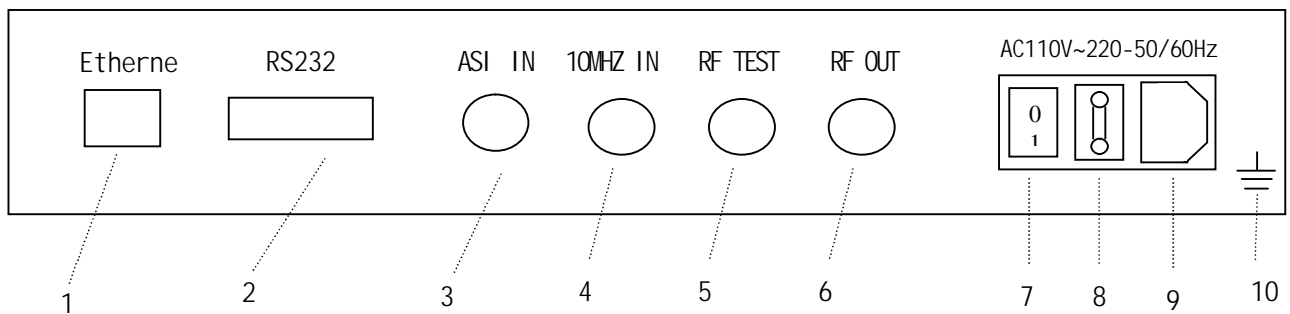

- 1: Ethernet interface
2. RS232 input interface
- 3: ASI Asynchronous Serial input interface
- 4: Modulator outside 10MHz source input interface
5. RF test output interface
6. RF out output interface
- 7: Power on-off
- 8: Power Fuse
- 9: Power socket
- 10: Grounding

Chapter 2 Installation guide

2.1 Acquisition check

Open the device package and check the articles, do check the packing material of samll parts,check packed goods according to packing list or below items:

- JXDH-6502QPSK Modulator 1set
- User manual 1copy
- Coaxial line with Q9 head for each ends 1 radix
- AC input power cord 1 radix

If there is any missing or mismatch of above items, please contact local dealer.

2.2 Installation preparation

Follow below steps when installing the device.The detailed installation will be described at the rest part of this chapter,the back panel illustration is for concrete position reference. Following content is the main for this chapter:

- Checking if there any possible missing or damage device during transport.
- Checking if the situation is suitable for installing.
- Install XDH-6502QPSKmodulator.
- Connecting signal wires.
- Connecting communication port (for option)

2.2.1 Installation flow per below chart:

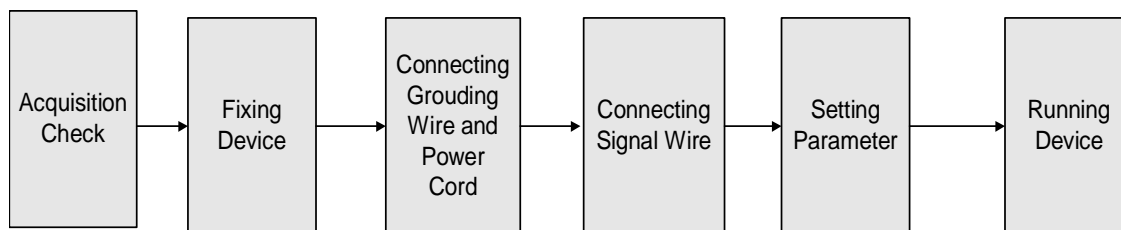

2.2.2 Environment Requirement:

Item	Requirement
Machine hall space	When user install machines array in one machine hall, the distance between 2 row of machine frames should be 1.2~1.5m and the distance to wall should be no less than 0.8m.
Machine hall floor	Electric Isolation, Dust Free, Volume resistivity of ground anti-static material : $1 \times 10^7 \sim 1 \times 10^{10} \Omega$, Grounding current limiting resistance : 1 M Ω , Floor bearing should be greater than: 450Kg/m ² .
Environment temperature	Under 5~40°C operate for long time, under 0~45°C operate for short time, installing air-conditioning is recommended.
Relative temperature	Under 20%~80% operate for long time, under 10%~90% operate for short time.
Pressure	86~105KPa.
Door & window	Installing rubber strip for sealing door-gaps and dual level glasses for window.
Wall	be covered with wallpaper, or brightness less paint, rather than easy pulverization dope.
Fire protection	Have Fire alarm system and extinguisher .
Power	Requiring device power, air-conditioning power and lighting power are independent to each other. Device power requires AC power 220V 50Hz, 50W Please carefully check before running.

2.2.3 Grounding requirement

- All function modules' good grounding designs are the base of reliability and stability of device. Also, they are the most important guarantee of lightning arresting and interference rejection. Therefore, system must follow this rule.
- Coaxial cable's outer conductor and isolation layer should keep sound electric conducting with the metal housing of device.
- Grounding conductor must adopt copper conductor in order to reduce high frequency impedance, and the grounding wire must be as thick and short as possible.
- The 2 terminals of grounding wire must make sure for well electric conducting, and process for antirust.

- It is prohibited that users use other devices as part of grounding wire's electric circuit
- The section of the conjunction between grounding wire and device's frame should be equal or greater than 25 mm²

2.2.4 Frame Grounding

All the machine frames should connect to protective copper strip. The grounding wire should be as short as possible and avoid circling. The section of the conjunction between grounding wire and grounding strip should be equal or greater than 25mm².

2.2.5 Device Grounding

Connecting the device's grounding rod to frame's grounding strip with copper wire.

Wire's Connection

The power supply outlet is located at the left of rear panel, and the power switch is just above it. The protective grounding wire connective screw is located at the down-left side of power supply outlet

- Connecting Power Cord

User can insert one end into power supply outlet, while insert the other end to AC power.

- Connecting Grounding Wire

When the device solely connects to protective ground, it should adopt independent way, say, share the same ground with other devices. When the device adopts united way, the grounding resistance should be smaller than 1Ω

⚠ Caution:

Before connecting power cord to Encoder, user should set the power switch to "OFF".

2.4 Signal Wire Connection

Signal wire connection including signal input wire and output wire, when signal wire connect with QPSK modulator should in coaxial line which with Q9 head for each ends. QPSK modulator output ports are one main output, one monitoring output, both are F head ports.

ASI input connection wire sketch:



2.4.1 ASI Output Port Connection

User can find ASI output port on the Equipment, according to connector mark described in the rear panel illustration, and then, connecting the ASI cable (in the accessories), one end to the JXDH-6502QPSK modulator's ASI output port and the other end to the scrambler's or Modulator's input port. multiplexer's ASI output port and its connected ASI cable connector illustrated as follow:



Chapter 3 Operation

JXDH-6502 QPSK Modulator have the user operation interface in the front panel, Before working, the default setting is available, user also can modify and re-setting the parameters of QPSK Modulator.

QPSK Modulator parameters including : Select language, RF Rate, Symbol rate, Convcode Coefficient , level Attenuator, Load Factory Setting.

The Menu with both Chinese and English Language for option, steps as below:

3.1 Keyboard Function of Front Panel

ENTER: Active the locked LCD, choose the parameter which to be modify, and confirm the modified parameter afterwards;

UP/DOWN/LEFT/RIGHT buttons: Select the position of the parameter, modify the activated parameter and turn over.

MENU: Menu, Return, Cancel.

After 2 minutes of no any operation, menu will return to the startup display, and waiting to be activated.

3.2 JXDH-6502QPSK Modulator Main menu

After installing the jxdh-6502 QPSK Modulator per above instruction, open power LCD display: "System initializing. Please be patient". Meantime the green power indicator of the front panel turn on. After a while the indicator turn off and LCD display: Software version V1.8 Press Enter unlock keyboard. Press Enter and enter the main menu of JXDH-6202 4 in 1 Encoder.(If the Red warning indicator doesn't turn on the same time, that is to say there is no transport stream be input into alarm.)

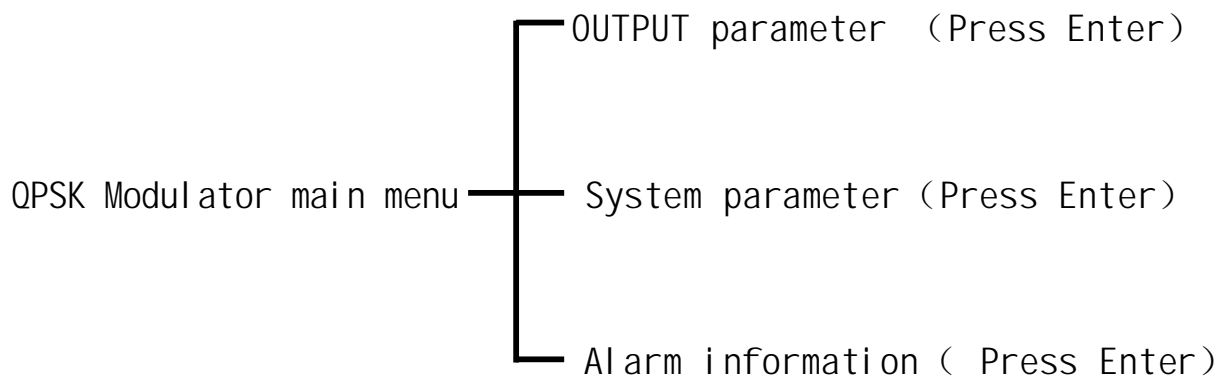

3.3 QPSK Modulator submenu

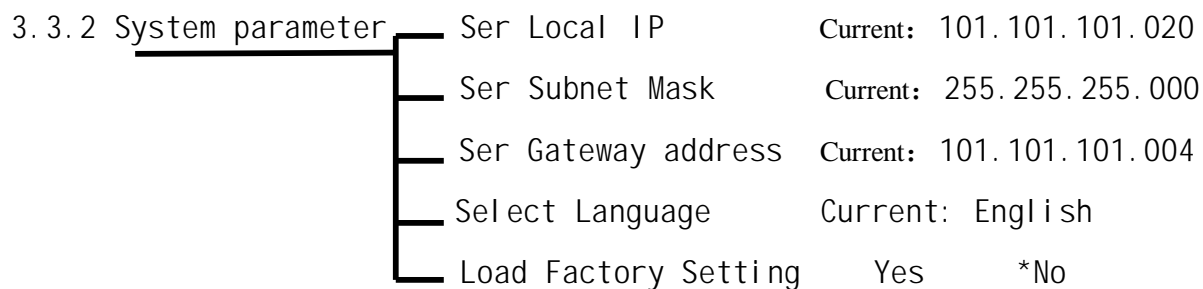
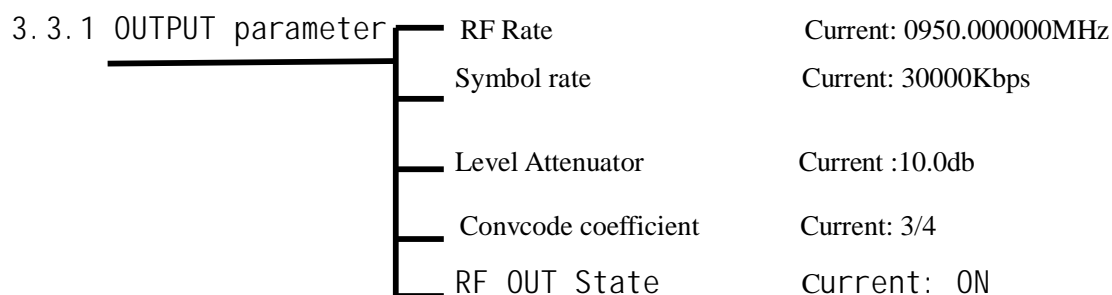

3.3.3 Alarm information — NO TS Input Elapsed: 0000222 minute

3.4 Setting

When you are at any parameter on submenu, just press “Enter” to enter the modify interface, and then press “Up, Down, Left, Right” to modify the value, and press “Enter” again to return to upper menu. Meantime you can see the modified parameter just now. Here are the detailed introduction.

3.4.1 Initialization

After finished installation per before instruction, open the power switch, the power indicator turn on green of the front panel, LCD screen display:

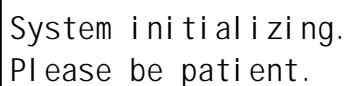

System initializing.
Please be patient.

After a while, the Initialization finished and the indicator turn off, LCD screen display:

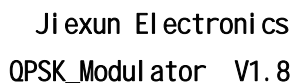

Jiexun Electronics
QPSK_Modulator V1.8

This time at the front panel, the red alarm indicator doesn't turn on, that means working normal. If the red alarm indicator turn on, namely there is no transport stream be input into alarm.

3.4.2 Enter Main menu of QPSK Modulator

Under above situation, press Enter to unlock the keyboard and enter into the main menu. Press “▲、▼” LCD screen in order cycle display as below:

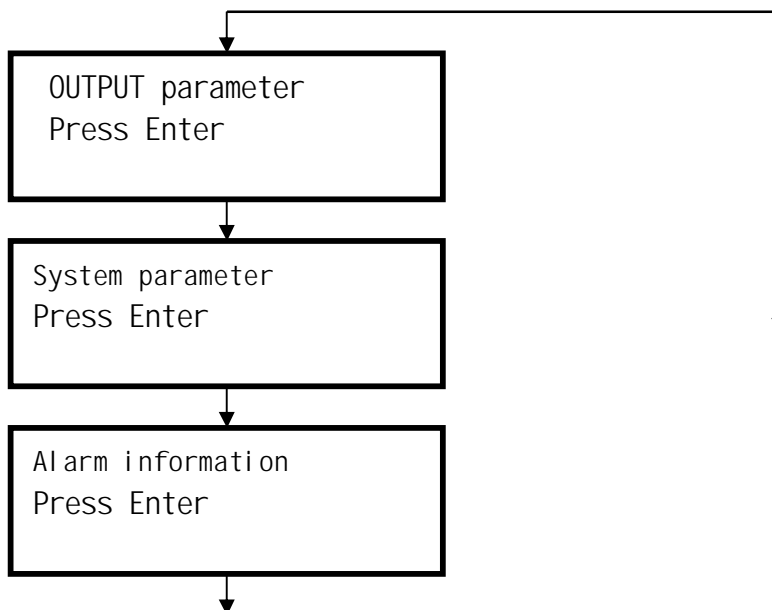

3.4.3 Paramiter modify illustration 1: RF Rate setting

After the Boot system initialization finished and the indicator turn off, LCD screen display:

Jiexun Electronics
QPSK_Modulator V1.8

Based on above station, press Enter unlock keyboard and enter QPSK Modulator main menu, the LCD screen red:

OUTPUT parameter
Press Enter

Re-press ENTER, LCD will display:

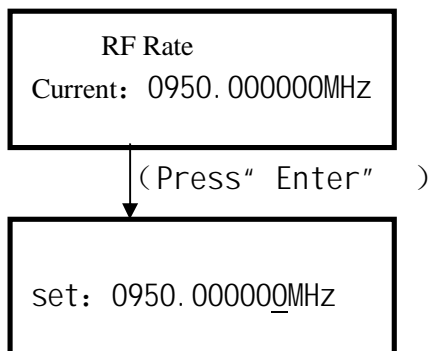

Re-press ENTER there will be a cursor on the screen, press LEFT/LEFT button and move”_”to the right place, press UP/DOWN to reset the parameter, Press ENTER again and the cursor disappear, this setting be finished. The modification of other parameters are in the same way.

3.4.4 Load Factory Setting

After above setting and press DOWN “▼” , the display reads:

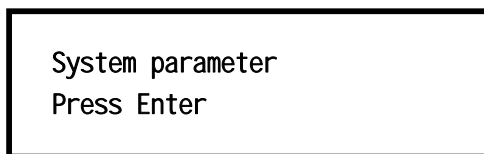

Re-press ENTER it will display:

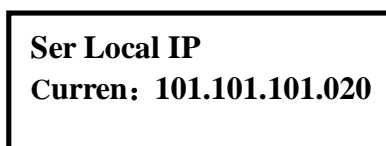

Press UP “▲”, when LCD display:

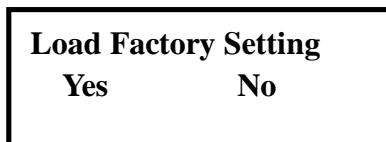

Press LEFT/RIGHT for option, press ENTER means enter to confirm restoring setting or not, press MENU to exit factory setting.

The symbol rate of this machine is 2~45Mbauds random optional; the value of symbol rate is associated with the efficient TS stream rate, the more stream rate, the more symbol rate; the relationship of symbol rate and TS stream rate is roughly that: symbol rate \approx efficient stream rate/1.6 (efficient stream rate can be measured by stream analysis equipment), generally speaking, the relationship between efficient stream rate and program quantity is approximate proportionality, more programs, more TS efficient stream rate.

3.5 Refer to the manual of network management for operation details.

3.6 System operation trouble shooting

3.6.1 LED Indicator status

There are 2 LED indicators on the panel:

(1) " Power" is the indicator of power supply

(2) " Alarm" is the alarm indicator for input stream

3.6.2 Trouble shooting

(1) " Power" indicator do not turn on, please check the power plug, and the power switch, to see if it is turned on.

(2) " Alarm" indicator turn on, and the machine do not operate properly, with fault alarm, please check "ASI IN" port, and the connecting cable, to find and solve the problem.