



JXDH-6302 QAM Modulator

User Manual

V1.5

Chengdu Jiexun Electronics Co.,Ltd

Charter One Outline

1.1 Outline

The manual describes the shell, assembly, functions, installation, and all the standard options which receivable of this QAM Modulator, including as follows:

- Summarize
- Installation
- Operation

1.2 Digital TV brief introduction

Digital TV is defined as provide satellite TV transmission and digital TV programs services by means of digital transmitting, thereby provide users high quality images and features services in the integrated digital TV channels services.

Digital TV system consists of three parts: digital TV head end systems, transmit networks, user end system. As bellow chart1:

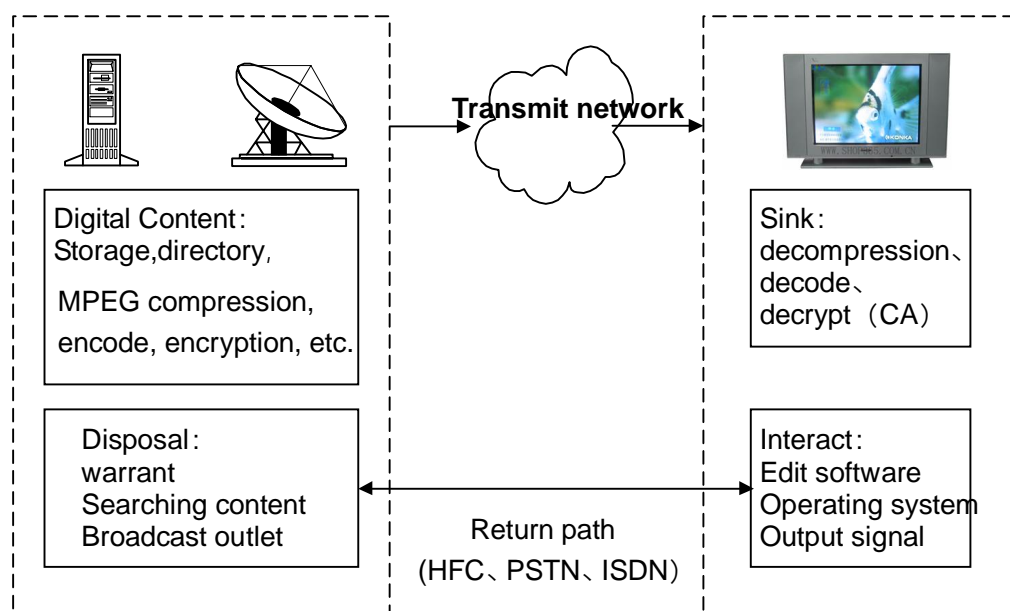

Digital TV is the necessary result of digital technology in the filed of development for TV. Digital TV is make analog signals to digital signals by sampling, quantify and encoding. Television system should include content, transmission and reception. The content is collection, make etc. Transmission is delivery the content to terminal

end via satellite, territory, cable network etc., thereby to composing a integrity digital TV system. The network for transmission digital system can be satellite, CATV, territory transmitting, and ADSL. In addition, The user end feedback the user’s interactive information to the digital TV head end system via the return path, the return path can be composed of network as HFC route, Wireless Return Path, PSIN, ISDN.

User end is what we called set top box(STB),User receive digital TV business information via STB, and shows them on the end equipments. Digital head end system can be divided to signal source processing, information processing and transmission processing three parts. For example various head programs, encoding equipments be part of signal source processing, program multiplex, scrambling etc. be part of information processing, QAM modulator, missed signals be part of transmission processing. It can be divided to user administer system, CA subsystem, DVB-C front end equipment subsystem, store and edit digital programs subsystem, digital broadcasting and middle subsystem etc., as following chart:

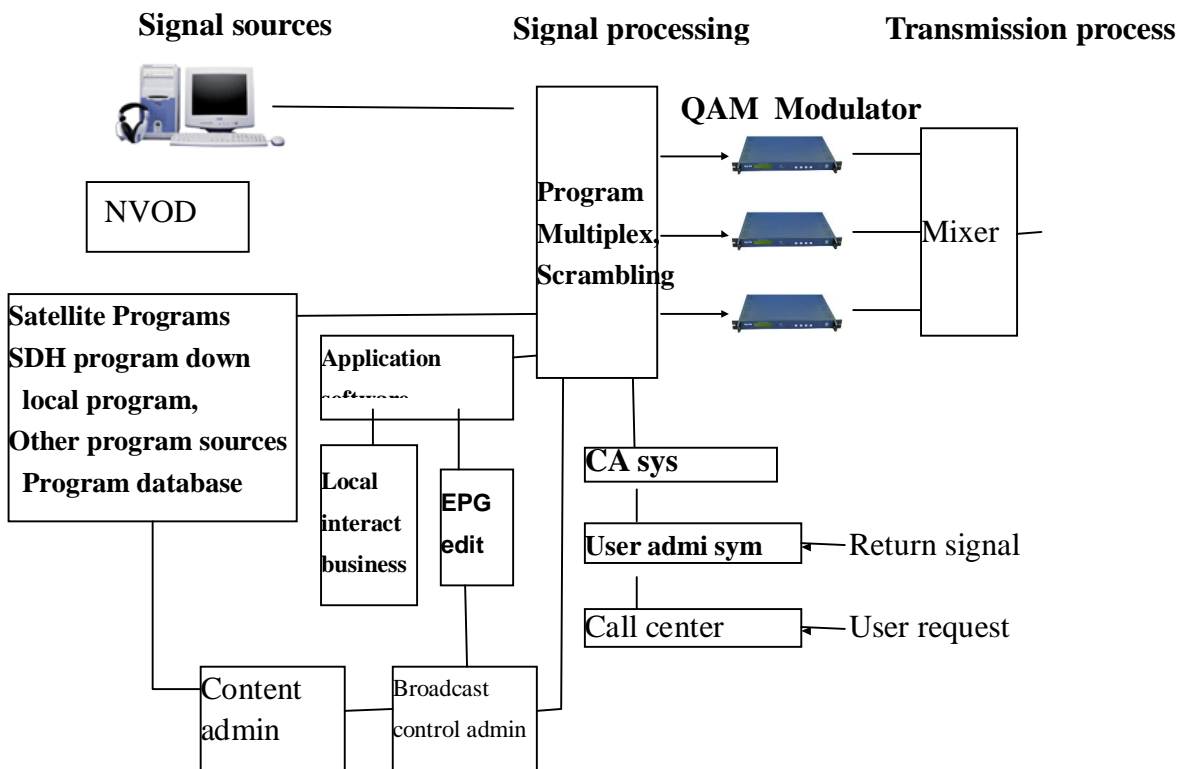

Terminology:

CA: Condition Access;

DVB-C: Digital Video Broadcasting-Cable;

MMDS: Multichannel Microwave Distribution System;

DSL: Digital Subscriber Line;

HFC: High-Frequency Current;

PSTN: Public Switched Telephone Network;

ISDN: Integrated Services Digital Network;

DVS: Digital Video System;

DTX: Digital TV Exchange platform;

QAM: Quadrature Amplitude Modulation;

STB: Set Top Box;

EPG: Electronic Program Guide;

MPEG: Moving Picture Express Group;

DVB: Digital Video Broadcasting;

PSI: Program Specific Information;

SI: Service Information;

ASI: Asynchronous Serial Interface.

Charter 2 Product Summarize

2.1 Summarize

In the broadcasting process of digital TV programs, QAM modulator mainly complete QAM modulate and up-frequency conversation process for TS stream, Apply to multi-level transmission, broadcasting of digital TV business.

QAM modulator mainly used in head end of digital TV broadcasting, it is composed by two modules QAM modulator and digital up-frequency conversation, modulate the input serial or parallel TS stream via the QAM modulator module, modulate to IF frequency, then pass the up-frequency conversation module to frequency transform, into standard channel or supplement channel which meet demand. Finally mixed enter into CATV network, and received by the terminal STB.

2.2 System components and working principle

2.2.1 System components

QAM Modulator components as below:

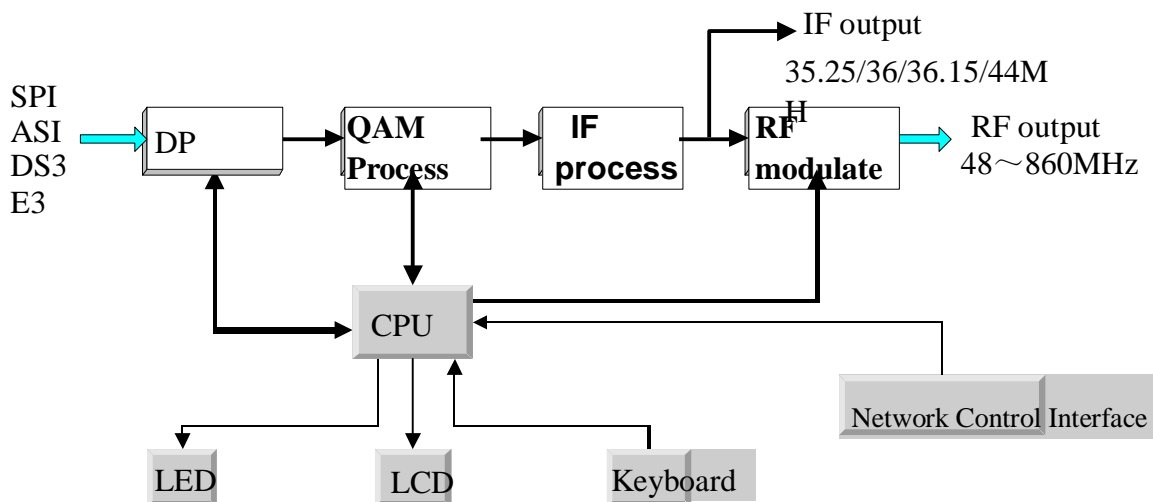

Chart 2-1 QAM digital modulator components

QAM modulator mainly composed by following modules:

- Data processing cell transform the input signals from all sorts of interfaces to standard signals and make necessary data processing, make the pretreatment of QAM modulate.
- QAM modulate cell modulates the data stream to spectrum signal, IF modulates output as 35.000-44.00MHz (stepping as 125KHz) adjustable.
- RF modulate cell transform the IF to 110-862 MHz to TV channels.
- CPU/LCD/LED/keyboard units complete keyboard input, LED display and smart control etc.

2.2.2 Principle

JXDH-6302 QAM Modulator comply with DVB-C standard(GY/T 170-2001、GY/T 106-1999),Digital signal will multi-process together with other data stream via MPEG-II compress and encode, the send to QAM modulator, QAM encode is according to DVB technical criterion, such as interweave, RS error correcting encode etc.. After processed by IF then up-frequency conversation to TV channels , so that to broadcast in HFC, microwave MMDS network, can be applied in digital TV, digital broadcasting, video-on-demand, internet, video conference and so on digital broadband application system.

2.3 Features

Support IYU-T.83A

Error correct encode completely meet DVB-C standard

Be workable under QPSK, 16QAM, 32QAM, 64QAM, 128QAM, 256QAM mode

Input interface: ASI and SPI (DS3/E3 optional)

Input data bit rate range: 1.5~51.6Mbps

Output data bit rate range: 2~56Mbps

Output signal Bandwidth(BW) range: 1.15~8.05MHz(roll down coefficient is 0.15)

Output data symbol rate range: 1~7Mbaud/s

RF frequency range: 110~862MHz

Output level range: 95dBuV~115dBuV (stepping -0.5dB/step adjustable)

188/204 packet length adaptable itself

Adopt big enough cache design, ASI interface support paroxysmal and symmetrical input TS stream, and can equilibrate and reforming the TS stream, enhance the efficiency of output TS stream.

Input data empty packet filtering and output data fill in.

PRC proofread function, can accurately correct several PCR of input data separately.

Real time inspect and display for the efficient TS stream.

Adaptable itself to filtering circuit design to ensure the excellent suppress capability out of band.

-20dB RF test mouth to monitor IF output.

Fault alarm display

LCD screen display

Network control interface, make centralize management, remote upgrade and maintenance (network management software only for option)

Power-off memory

2.4 Data Interface

2.4.1 ASI interface (Asynchronous Serial Interface)

A. Input

Socket: BNC

Impedance: 75Ω

Packet format: 188 or 204 byte(no route encode)

Route data speed velocity: 270Mbps

Max efficient data: 51.6Mbps

Standard: meet DVB standard, support paroxysmal and symmetrical input TS stream.

B. Ring route output

Socket: BNC

Impedance: 75Ω

2.4.2 SPI Input Interface (Synchronous Parallel Interface)

Socket: DB-25 female

Packet format: 188 or 204 byte(no route encode)

Standard: compatible of DVB, LVDS working methods.

2.5 IF Interface

A. IF output

Linker: BNC socket

Impedance: 75Ω

Center frequency: 35.000~44.000MHz adjustable (stepping 125KHz)

IF bandwidth: ≤8MHz

Return loss: ≥18dB

Input level: 100dBuV

2.6 RF Interface

A. RF output

Connector: F jack (the metric system)

Impedance: 75Ω

Output frequency: 110MHz~862MHz (provide per model)

Return loss: ≥12dB

Output level: Max 115dBuV(adjustable, stepping at 0.5dB)

Level adjustable range: 0~20dB

Carrier suppression: >55dB

Modulate error rate(MER): ≥32dB(closing balance), ≥45dB(opening balance)

Bit modulate error rate(BER): ≤ 1×10^{-8}

SNR(Outside band): ≥50dB

B. RF test output

Connector: BNC

Impedance: 75Ω

Output level: 75dBuV~95dBuV (adjustable)

2.7 Signal channel coding

Modulate mode: 16QAM, 32QAM, 64QAM, 128QAM, 256QAM

Channel coding: comply with DVB standard RS coding

IF modulate error rate(MER): ≥44dB

SNR(outside band): ≥50dB

2.8 Network administration interface

Ethernet interface: Ethernet IEEE802.3, RJ45interface

Software agreement: the SNMP agreement

2.9 power supply

Voltage: 100-240VAC

Frequency: 50Hz±2%

Electric Power: 20W

2.10 Working environment

Surrounding temperature: +5°C~45°C

Storage temperature: -25°C~+55°C

Relative humidity: 10~75%

2.11 Radiate and safety requirements

Comply with GB13837-92 and GB8898-88 standard.

2.12 Dimension

44.5mm (height, 1U) ×483mm(width,19") ×300mm(deep)

2.13 Weight

3.5 kg

2.14 Figure and description

Front panel sketch:

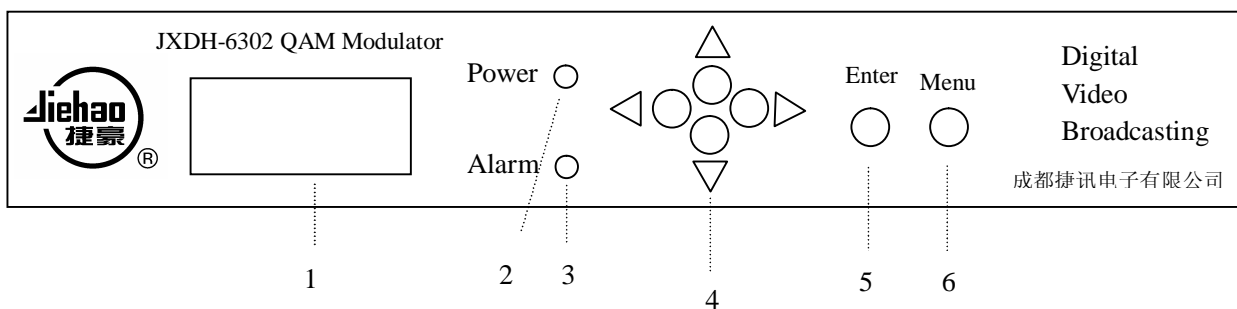

1.	LCD screen display
2.	Power supply indicator
3.	Fault alarm indicator
4.	UP/DOWN/LEFT/RIGHT button
5.	Confirm Button
6.	Menu/Cancel button

Rear panel sketch:

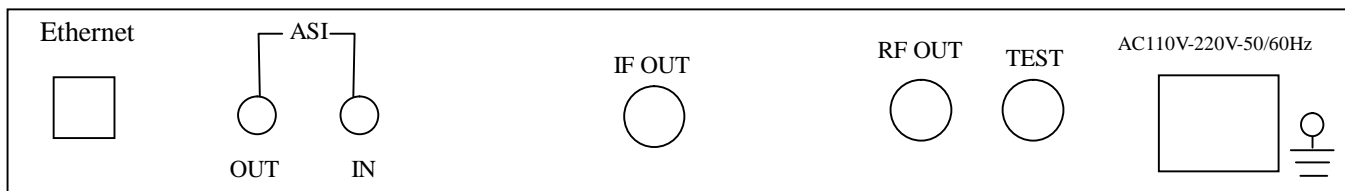

2.14.1 SPI input interface:

No.	Signal name	description	No.	Signal name	description
1	CLK-A	Signal clock	14	CLK-B	Signal clock
2	GND	grounding	15	GND	Grounding
3	D7-A	Data 7th	16	D7-B	Data 7th
4	D6-A	6 th	17	D6-B	6 th
5	D5-A	5 th	18	D5-B	5 th
6	D4-A	4 th	19	D4-B	4 th
7	D3-A	3 rd	20	D3-B	3 rd
8	D2-A	2 nd	21	D2-B	2 nd
9	D1-A	1 st	22	D1-B	1 st
10	D0-A	0	23	D0-B	0
11	DVALID-A	Data valid	24	DVALID-B	Data valid
12	PSYNC-A	Packet synchro	25	PSYNC-B	Packet synchro
13	Cable 地	Cable shielding line			

Charter 3 Operation

QAM modulator front panel is for user operate, before normal operation you can keep the default setting witch is the factory setting, and you can setting for input, output parameter, operation. Input setting including selecting input interface, setting output parameter.

3.1 Setting operation

3.1.1 Boot interface:

After boot it, the LCD displays as below:

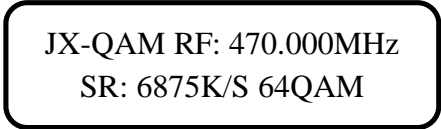

Here pressing RIGHT button, the screen displays as below:

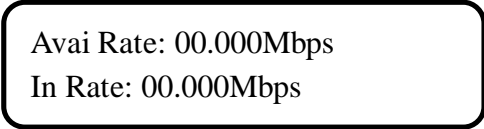

It is for inspect the input code rate timely, press "Menu" for quit.

3.1.2 Main menu setting:

Click on "Menu" enter main menu, select the item by the DOWN button, press "Enter", the sketch as below:

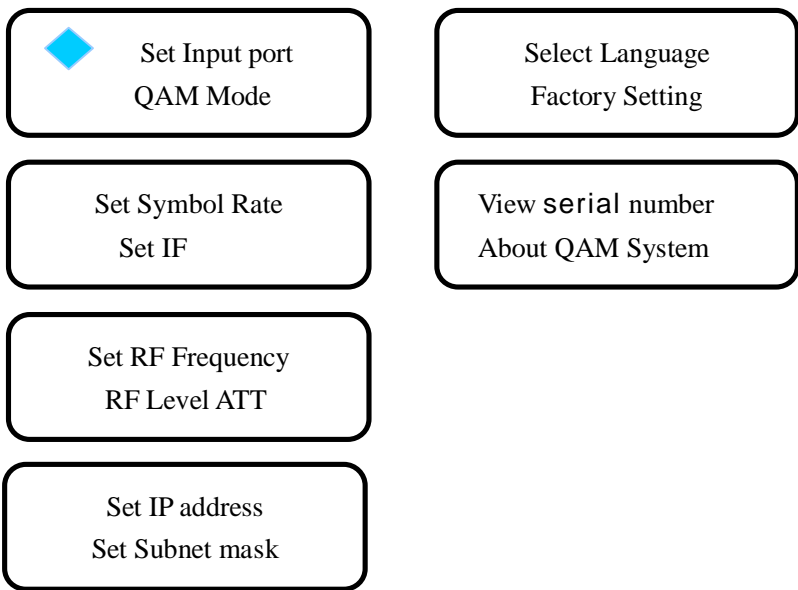

3.1.3 Input interface setting:

Moving the cursor to input interface setting, press “Enter”, select the items by LEFT,RIGHT button, it displays as below, press “Enter” after confirm selection for save.

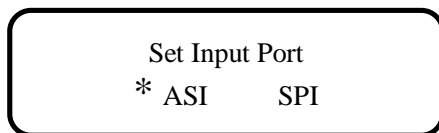

3.1.4 QAM mode setting:

Press “Enter” to QAM mode setting, , select the item which you need by pressing UP DOWN button, it display as below, press “Enter” after confirm selection for save.

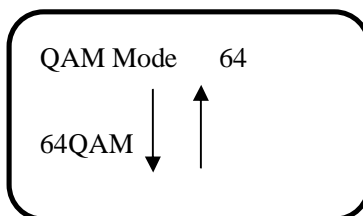

3.1.5 Symbol rate setting:

Press “Enter” to Symbol Rate Setting, press the up down button will change the number while move cursor by pressing left right button to select the item which need to be reset, it display as below, after setting press "Enter" for save.

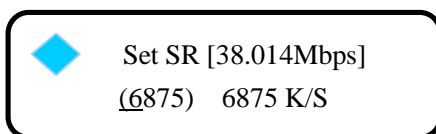

3.1.6 IF Frequency:

Press “Enter” to IF Frequency , press the up down button will change the number while move cursor by pressing left right button to select the item which need to be reset, the frequency range 35.000~44.000MHz adjustable, it display as below, after setting press “Enter” for save.

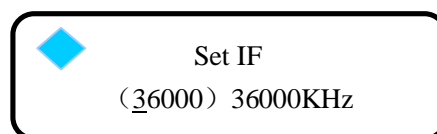

3.1.7 RF Output Frequency Setting

Press “Enter” to RF Output Frequency Setting, press up down button will change the number while move cursor by pressing left right button to select the item which need to be reset, the frequency range: 110MHz~862MHz, it display as below, after reset press “Enter” for save.

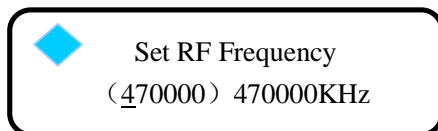

3.1.8 RF Output level

Press “Enter” to RF Output Level, press up down button to change the number, the adjustable range is 0_20dB, stepping at 0_20dB, it displays as below, press “Enter” after reset for save.

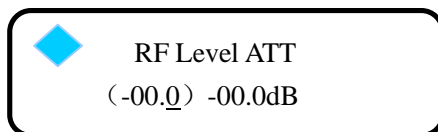

3.1.9 IP Address Setting

Press “Enter” to IP Address Setting, change the number by press up down button, move cursor by pressing left right button to select the item to be reset, it display as bellows, press “Enter” after reset for save. (Note: the beginning 9 digits of QAM IP address and of the server are the same, the ending 3 digits are different.)

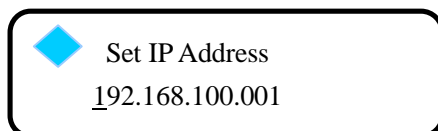

3.1.10 Subnet Mask

Press “Enter” to Subnet Mask, change the number by press up down button, move cursor by press the left right button to select the item to be reset, it display as

bellows, press “Enter” after reset for save. (Note: the subnet mask of QAM and server are the same.)

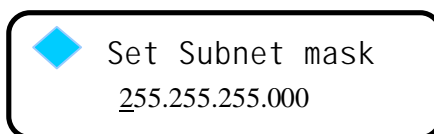

3.1.11 Language

Press “Enter” to Language, move cursor by pressing left right button to choose the needed language, it display as below, press “Enter” after reset for save.

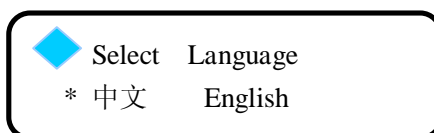

3.1.12 Restore Factory Setting

Press “Enter” to Restore Factory Setting, move cursor by press left right button to choose confirm / cancel, it display as below, press “Enter” after select for save.

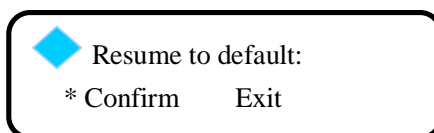

3.1.13 Product No. and About QAM Modulator

Press “Enter” to Product Serial No., it displays its serial number from the factory.

Press “Enter” to About QAM Modulator, it displays the product’s type and company’s website.

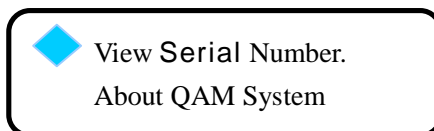

Charter 4 Installation Guide

4.1 Inspection upon Reception

Open the package inspect the article, inspect the package for small parts without fail, check the articles according to the packing list or below items:,

- QAM Modulator
- User Manual
- Q9 connector 1
- AC power source wire

In case of the actual articles doesn't accord with above list, please advise us immediately.

4.2 Installation preparation

When install this device, please follow steps as below. Each of the install details will be described in rest of this charter, refer to the rear panel for the specific position.

This charter contain below contents:

- Check if there any device lost or damaged during the transportation.
- Get ready the surrounding condition for the installation.
- Install QAM Modulator.
- Connect the signal wires.

4.2.1 Installation process as below chart:

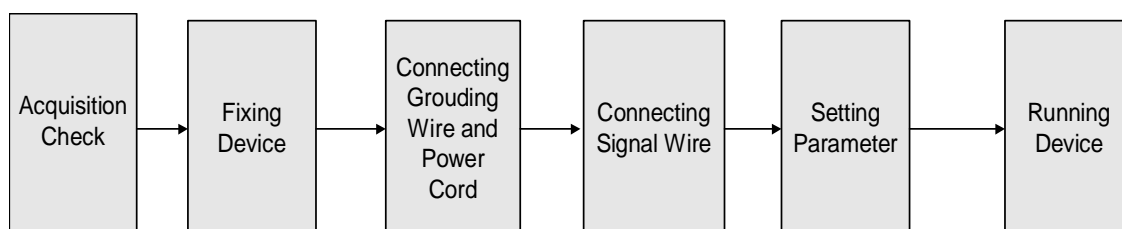

4.2.2 Surrounding condition requirement:

Item	Requirements
Machine room space	When install many machines array in one room, the distance between 2 row should be 1.2~1.5m and the distance to wall should be no less than 0.8m.
Machine room Floor	Non conductive, dust proof, Volume resistivity of ground anti-static material : $1 \times 10^7 \sim 1 \times 10^{10} \Omega$, Grounding limiting resistance : $1 M\Omega$ Floor bearing should be greater than: 450Kg/m^2
Surrounding temperature indoor	Under $5 \sim 40^\circ\text{C}$ operate for long time, under $0 \sim 45^\circ\text{C}$ operate for short time, 在 $5 \sim 40^\circ\text{C}$, installing air-conditioning is recommended.
Relative temperature	Under 20%~80% operate for long time, under 10%~90% operate for short time.
Atmospheric pressure	86~105KPa.
Door and windows	Must be sealed by dustproof rubber strip, with double-deck glass window is recommended, and strictly sealed.
Wall indoor	Can be covered with wallpaper, or brightness less paint, rather than easy pulverization dope.
Fire protection	Machine room should matched Fire alarm system and extinguisher .
Power supply	Requiring device power, air-conditioning power and lighting power three independent supply systems. Device power requires AC power 110V 60Hz, Please check carefully devices running.

4.2.3 Grounding Requirement

- All function modules' good grounding designs are the base of reliability and stability of device working. Also, they are the most important guarantee of lightning arresting and interference rejection. Therefore, system must follow above rule.
- Coaxial cable's outer conductor and both ends of shield layer should keep soundly electric conducting with the metal shell of the device.
- Grounding conductor must adopt copper conductor in order to reduce high frequency impedance, and the grounding wire must be as thick and short as possible.
- The 2 ends connection points of grounding wire must make sure for well electric conducting, disposal of anti- corrosion.
- It is prohibited use other devices as part of grounding wire's electric circuit

- The junction cross-section of grounding wire which connect machine cabinet to lightning protection unit should no less than 25mm².

4.2.4 Cabinet Grounding

In the same machine room, each cabinets grounding ends should connect to the appointed copper strips separately. The grounding wire should be as shorter as possible to avoid being coiled, cut it to short if the wire is too long when installing. The wire's cross-section where grounding end connecting to strips should be no less than 25mm².

4.2.5 Device Grounding

When make device grounding, Connect the dependency connection pole to the chief cabinet dependency connection strips by wire.

4.3 Wires Connection

The power supply jack placed at the right side of the rear panel, at its left is power switch. At the right lower side it is grounding connect bolt.

- Connect power wire

One end of the power supply wire inserts the AC power jack, while the other end connects with the QAM Modulator.

- Connect grounding wire

When connect separately to the room's dependency, adopt the mode of independent grounding, that is grounding together with other devices(such as transmit devices), when united grounding the grounding impedance should less than 1Ω

Caution:

Before connect to the power source wire, make sure the switch of QAM Modulator should be "OFF", and together with the power supply system be grounding.

4.4 Signal wire Connection

4.4.1 RF Output Cable

QAM Modulator adopt BNC connector, connecting by 75Ωcoaxial-cable as picture. The joint is BNC connector, the device end is cathode ,the cable be anode.



4.4.2 Connect ASI Output

When set up QAM Modulator ASI input, the ASI input interface (ASI IN) should be connect with other MPEG-2/DVB devices which also have ASI output interface by 75Ω coaxial-cable, that is to say when connect, 1 device's ASI output connect to another one's ASI input interface. ASI input interface adopt BNC connector as below picture:

