



JXDH-6002-6 QPSK Demodulator User Manual

V3.0

Chengdu Jiexun Electronics Co., Ltd.

Charter 1 Product Outline

1.1 Outline

JXDH-6002-6 QPSK TS Demodulator used for receiving and transferring DVB-S channels to TS stream signal directly, then convert via FPGA outputting ASI to devices such as Multiplexer or Modulator. No need to do process of decompression, encoding etc. It is widely used in satellite digital TV, data broadcasting, Internet, etc.

1.2 Features

- Support 6 routes LNB independent input or loop input, 1 route ASI-TS stream output, one backup of ASI-TS stream output;
- LNB input frequency range: 950~2150 MHz;
- Interface comply with ASI standard;
- DVB/MPEG-2 both compatible;
- SCPC/MCPC compatible, can receive all domestic and foreign non-encrypted digital programs;
- Polarization mode: Horizontal/vertical for optional;
- F head for optional;
- C/Ku band compatible;
- Adopt ultra-low threshold integrated tuner, high reliability, good performance, power off memory;
- Stable and reliable performance, strong anti-interference capability.

Application:

- Digital satellite television broadcasting;
- MMDS digital TV front-end;
- Digital cable television network

1.3 Performance Indicator

Model	JXDH-6002-6 QPSK TS Demodulator
Input Frequency	950~2150MHz
Signal level	-75~-25dBm
IF band width	27~36MHz
Modulate mode	QPSK (DVB-S)
Impedance	75Ω

ASI Output (Asynchronous serial interface)

Socket	BNC
Impedance	75Ω
Packet format	188/204byte (optional)
Channel data rate	108Mbps
Standard	comply with DVB standard

1.4 System Components and Principle

1.4.1 System components

JXDH-6002-6 QPSK Demodulator:

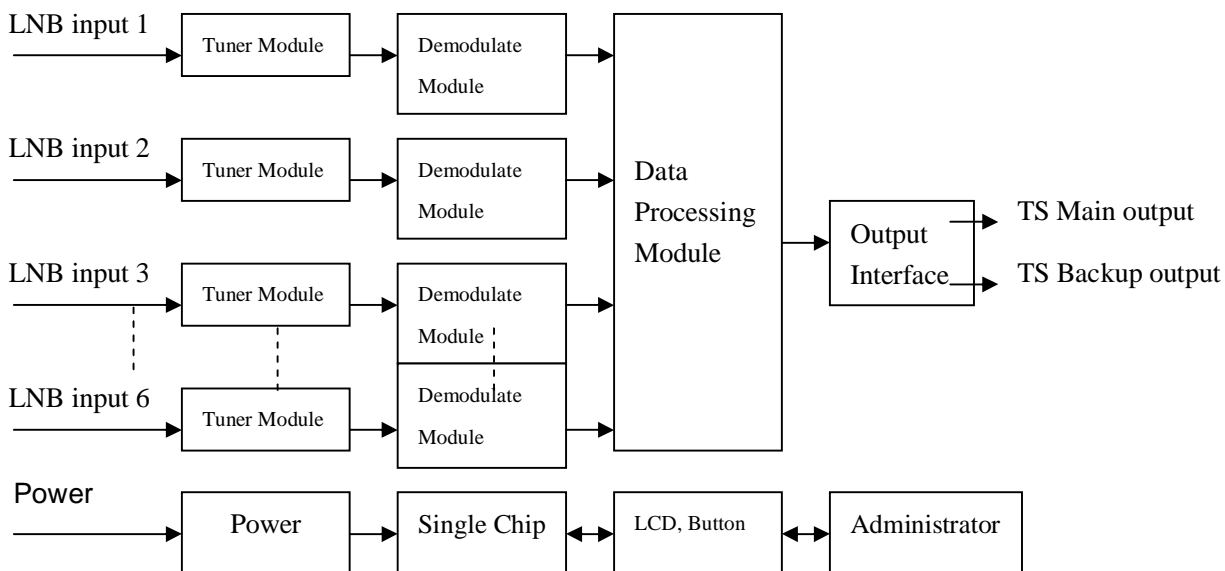

1.4.2 Working principle

1.4.2.1 Tuner

Satellite signal input via LNB, frequency range at 950~2150 MHz, after high-precision digital tuner comes corresponding IQ signal, then IQ signal be sent to date demodulator chip, afterwards, standard synchronous parallel data output.

1.4.2.2 Data processor (FGPA)

After FPGA got corresponding parallel data, it output standard MPEG-2 stream (ASI interface) digital signal, for the use of devices such as Multiplexer, scrambler, modulator, and so on.

1.5 Panels and Instructions

1.5.1 Front panel

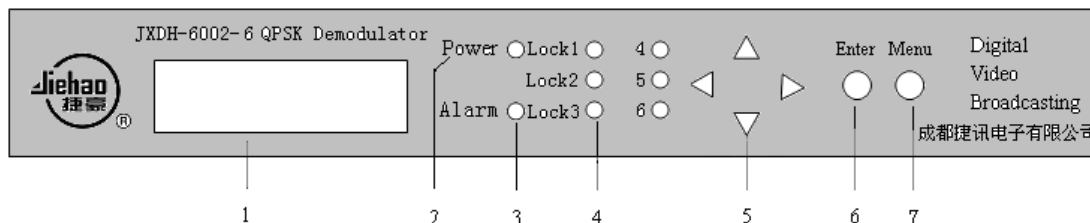

- 1-LCD display
- 2-Power indicator
- 3-Alarm/lock indicator
- 4-Lock indicator
- 5- UP/DOWN, LEFT/RIGHT Button
- 6-Confirm/Unlock button
- 7-Menu Button

1.5.2 Back Panel

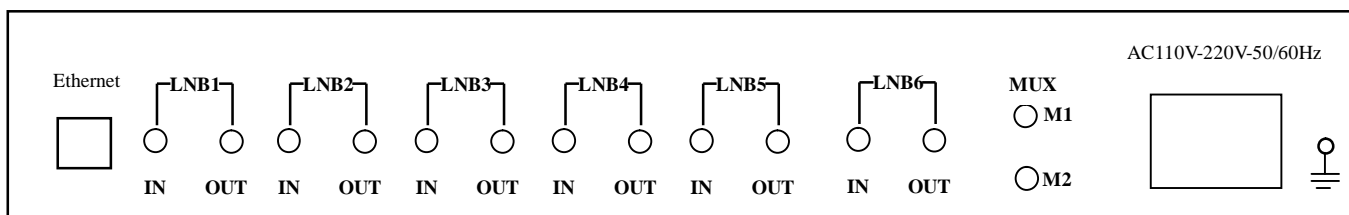

From left to right followed by:

1. Network interface: RJ45
2. LNB input 1, LNB loop output 1;
3. LNB input 2, LNB loop output 2;
4. LNB input 3, LNB loop output 3;
5. LNB input 4, LNB loop output 4;
6. LNB input 4, LNB loop output 5;
7. LNB input 4, LNB loop output 6;
8. MUX, multiplexed bit stream output 1, 2
9. Power switch: "ON" for turn on, "OFF" for turn off.
10. Fuse pipe: 2A/AC250V
11. Power socket: connect to AC180~AC240V, 20~60MHz.

- LNB input port: receive the signal which receive from the satellite antenna via F head.
- LNB loop output port: it can put the same satellite signal sources supply to other LNB input port or to other input device.

Charter 2 Installation Guide

1.1 Inspection upon reception

Open the device packing carton, make sure to check all the packages for the small parts, check the commodities according to the packing list or below items:

- JXDH-6002-6 QPSK TS Demodulator 1set
- User manual 1 pc
- Dual Q9-ends coaxial cable 4 pc
- AC power line 1 pc

In case of any discrepancies, please contact the dealer at once!

1.2 Installation

Following below steps once you are ready to install the device. The every details of installing will be described in rest of this chapter, please refer to the panel instructions for the specific location. This chapter includes the following:

- Check any possible losing or damage occur during the transport;
- Get ready the good environment for installation;
- Install JXDH-6002-6 QPSK TS Demodulator;
- Connect to the signal lines;
- Connect to the communication port (optional)

1.2.1 Device installation flow chart as following:

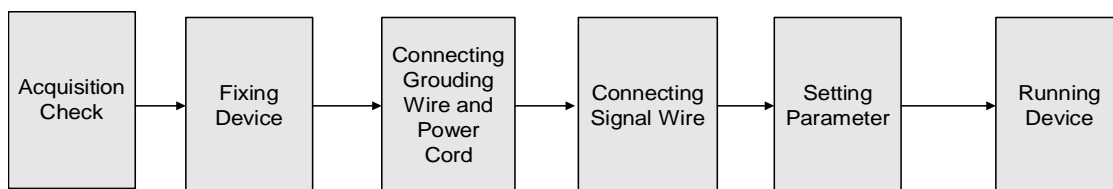

1.2.2 Environment requirement:

Item	Requirement
Machine hall space	When many arrays machine cabinets there, make sure 1.2~1.5m door to door between one cabinet to another, distant the wall at least 0.8m.
Machine hall floor	Electric Isolation, Dust Free Volume resistivity of ground anti-static material: $1 \times 10^7 \sim 1 \times 10^{10} \Omega$. Grounding current limiting resistance: $1M\Omega$;

	Floor bearing should be greater than 450Kg/m ² .
Environment temperature	5~40°C sustainable working, 0~45°C short time working, To install air-conditioning is recommended.
Relative temperature	20%~80% sustainable working, 在 10%~90% short time working
Pressure	86~105KPa.
Door & window	Installing rubber strip for sealing door-gaps and dual level glasses for window.
Wall	It can be covered with wallpaper, or brightness less paint; but do not paint easy pulverable paint.
Fire protection	Fire alarm system and extinguisher
Power	Requiring device power, air-conditioning power and lighting power are independent to each other. Device power requires AC power 220V 50Hz. Please carefully check before running.

1.2.3 System grounding requirement

- All function modules' good grounding designs are the base of reliability and stability of device. Also, they are the most important guarantee of lightning arresting and interference rejection. Therefore, system must follow this rule.
- Coaxial cable's outer conductor and isolation layer should keep sound electric conducting with the metal housing of device.
- Grounding conductor must adopt copper conductor in order to reduce high frequency impedance, and the grounding wire must be as thick and short as possible.
- The 2 terminals of grounding wire must make sure for well electric conducting, and process for antirust.
- It is prohibited that users use other devices as part of grounding wire's electric circuit
- The section of the conjunction between grounding wire and device's frame should be equal or greater than 25mm².

1.2.4 Frame grounding

All the machine frames should connect to protective copper strip. The grounding wire should be as short as possible and avoid circling. The section of the conjunction between grounding wire and grounding strip should be equal or greater than 25mm²

1.2.5 Device grounding

Connecting the device's grounding rod to frame's grounding strip with copper wire.

1.3 Wires Connection

The power supply outlet is located at the left of rear panel, and the power switch is just above it. The protective grounding wire connective screw is located at the down-left side of power supply outlet

- Connecting Power Cord

User can insert one end into power supply outlet, while insert the other end to AC power.

- Connecting Grounding Wire

When the device solely connects to protective ground, it should adopt independent way, say, share the same ground with other devices. When the device adopts united way, the grounding resistance should be smaller than 1Ω

⚠ Caution:

Before connecting power cord and LNB line to JXDH-6002-6 QPSK TS Demodulator, make sure have set the power switch to "OFF".

1.4 Signal Wire Connection

The signal line connections include the connection of input signal wire and the connection of output signal wire. The input signal line connect with the demodulator LNB IN, ASI output port should connect with coaxial cable which witch dual Q9-ends.

ASI input connection wire:



1.4.1 ASI input connection

Find the ASI output interface according to the rear panel instruction, connect one end of the dual Q9-ends coaxial cable to the ASI output port, the other end of the cable connect to the ASI input interface of TS multiplexer or modulator such

devices, illustration as following:



2 Front panel keyboard function introduction

2.1 Keyboard function

Left/Right: Move cursor;

Up/Down: Modify parameters;

Enter: Confirm and store modification, also for select;

Menu: Circle main menu and channel parameters state inquiry even cancel modify etc.

Note: make sure press confirm button once you setup new parameters, when it displays “Saving.....Done” means the parameters setup successful; while the parameter displays symbol “*”, it means this parameter in effective, otherwise means keep the original parameters or to re-select parameters.

2.2 Mode select

Startup displays:

System Initializing
Please be patient

Then display main screen:

LNB1: UnLock
F:04040MHz SR:27500k

In the main screen, press Up/Down button, you can see the correspondingly channel signal work situation, down-link frequency or symbol rate value, you can see if the setting for this channel is right or wrong, lock or unlock. It can help us to find the problem promptly and solve it. If the top right screen displays “Unlock” means this channel signal unlocked, you'd better check each parameter and check if the cable connected right or wrong; when top right displays “Locked” mean this channel working normal. And the corresponding channel indicator light green.

2.3 Parameters modification and setting up

Menu Framework:

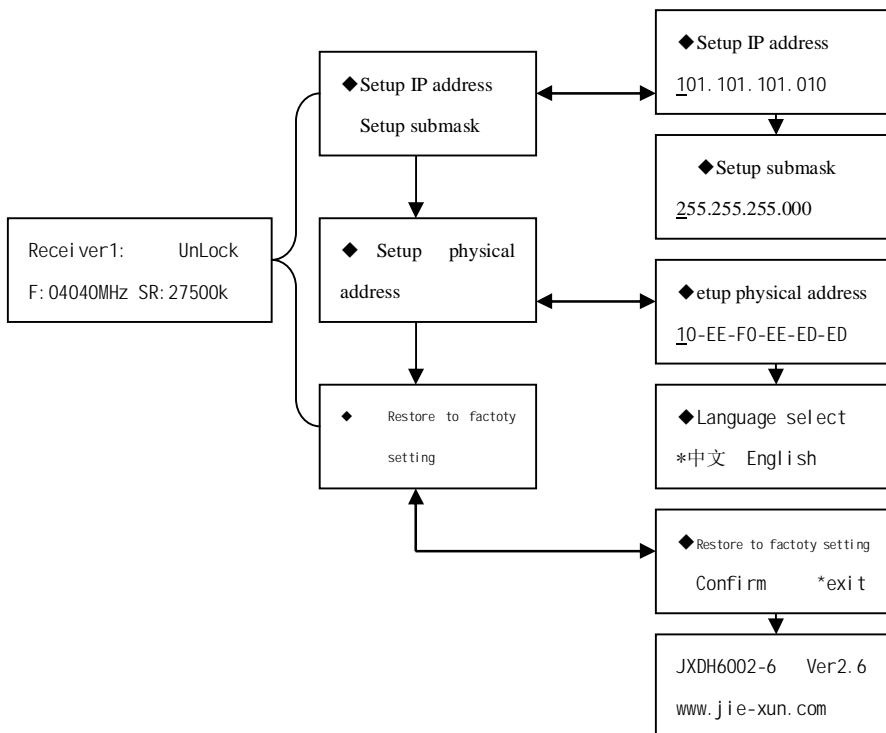

2.3.1 Operation instruction

(1) In main screen, press menu button, it displays:

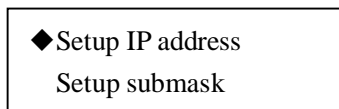

Move cursor“◆” down to the front of “Set IP Address.”, press enter button, enter into screen as below

::

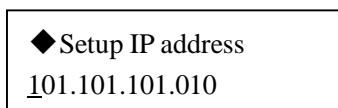

Move Left/Right button and Up/Down button, modify the parameter to the value you want to set, then press enter button to confirm, it displays “Saving.....Done”, means modified successful. Press menu button to return.

(3) Go on moving down the cursor “◆” to the front of “Setup submask”, press enter button, it displays:

```
◆ Set submask
 255.255.255.000
```

Move Left/Right and Up/Down button, modify the parameter to the value you want to set, then press enter button to confirm, it displays “Saving.....Done”, means modified successful. Press menu button to return.

(3) Go on moving down the cursor “◆” to the front of “ Se physical Address.”, press enter button, it displays:

```
◆ Setup physical address
10-EE-F0-EE-ED-ED
```

Move Left/Right and Up/Down button, modify the parameter to the value you want to set, then press enter button to confirm, it displays “Saving.....Done”, means modified successful. Press menu button to return.

(4) Go on moving down the cursor “◆” to the front of “Select Language”, press enter button, It displays:

```
◆ Select Language
中文 *English
```

Move Left/Right button, the language marked with symbol star “*” will be the selected language, press enter button to confirm, press menu button to return.

(5) Go on moving down the cursor “◆” to the front of “Factory settings”, press enter button, it displays:

```
◆ Factory Settings
Confirm *Exit
```

Move Left/Right button, when star symbol “*” point to “Exit”, press enter button will not back to factory setting, conversely is confirm to back to factory setting. Press menu button to return.

(6) Go on moving down the cursor “◆” to the front of “About System”, press enter button, it displays:

```
Demodulator 6
Ver2.6
```

Press menu button to return.

2.3.2 Network management details refer to its User Manual.

3 System errors and Debugging

3.1 Status of indicator lights

There are 8 LED indicators on the front panel, as below:

- (1) “Power” for power (Green), when turn on power switch, indicator lighting, means the device working normal.
- (2) “Alarm” for alarm (Red),, indicator turn on when output stream overflow
- (3) If “Lock” indicator not on light, it means the device work abnormal, once it lighting green, the device working normal.

3.2 Trouble Shooting

- 1). “Power” indicator not on light

Please check the power cord if inserted into the power socket correctly, or the power switch is in the status of ON or OFF.

- (2) “Alarm” lighting

Please check the stream of the 6 programs, and total value of the stream, increas the output stream value.

- (3) “Lock” not on light

The device working abnormal, it is fault alarming. Please check the connection wire of LNB IN and the parameter value according to the channel number is right or wrong, so that to do trouble shooting.